

SPECIFICATIONS SUBJECT TO CHANGE WITHOUT NOTICE

Notice

While reasonable efforts have been made to assure the accuracy of this document, Telit assumes no liability resulting from any inaccuracies or omissions in this document, or from use of the information obtained herein. The information in this document has been carefully checked and is believed to be entirely reliable. However, no responsibility is assumed for inaccuracies or omissions. Telit reserves the right to make changes to any products described herein and reserves the right to revise this document and to make changes from time to time in content hereof with no obligation to notify any person of revisions or changes. Telit does not assume any liability arising out of the application or use of any product, software, or circuit described herein; neither does it convey license under its patent rights or the rights of others.

It is possible that this publication may contain references to, or information about Telit products (machines and programs), programming, or services that are not announced in your country. Such references or information must not be construed to mean that Telit intends to announce such Telit products, programming, or services in your country.

Copyrights

This instruction manual and the Telit products described in this instruction manual may be, include or describe copyrighted Telit material, such as computer programs stored in semiconductor memories or other media. Laws in the Italy and other countries preserve for Telit and its licensors certain exclusive rights for copyrighted material, including the exclusive right to copy, reproduce in any form, distribute and make derivative works of the copyrighted material. Accordingly, any copyrighted material of Telit and its licensors contained herein or in the Telit products described in this instruction manual may not be copied, reproduced, distributed, merged or modified in any manner without the express written permission of Telit. Furthermore, the purchase of Telit products shall not be deemed to grant either directly or by implication, estoppel, or otherwise, any license under the copyrights, patents or patent applications of Telit, as arises by operation of law in the sale of a product.

Computer Software Copyrights

The Telit and 3rd Party supplied Software (SW) products described in this instruction manual may include copyrighted Telit and other 3rd Party supplied computer programs stored in semiconductor memories or other media. Laws in the Italy and other countries preserve for Telit and other 3rd Party supplied SW certain exclusive rights for copyrighted computer programs, including the exclusive right to copy or reproduce in any form the copyrighted computer program. Accordingly, any copyrighted Telit or other 3rd Party supplied SW computer programs contained in the Telit products described in this instruction manual may not be copied (reverse engineered) or reproduced in any manner without the express written permission of Telit or the 3rd Party SW supplier. Furthermore, the purchase of Telit products shall not be deemed to grant either directly or by implication, estoppel, or otherwise, any license under the copyrights, patents or patent applications of Telit or other 3rd Party supplied SW, except for the normal non-exclusive, royalty free license to use that arises by operation of law in the sale of a product.



Applicability Table

PRODUCT
GE864-QUAD V2
GE864-GPS
GC864-QUAD V2
GC-QUAD V2 with SIM holder



Contents

1. Introduction	8
1.1. Scope	8
1.2. Audience.....	8
1.3. Contact Information, Support.....	8
1.4. Document Organization	9
1.5. Text Conventions	9
1.6. Related Documents	10
2. The GE864-QUAD V2\GPS and GC864-QUAD V2	11
2.1. Products Overview	11
2.2. Target Market.....	11
2.3. Product Features	12
3. Product Description.....	16
3.1. Size and 2D mechanical drawing	16
3.1.1. Mechanical View of Telit GC864-QUAD V2 with SIM Holder	18
3.2. Weight	19
3.3. Environmental requirements	19
3.3.1. Temperature range	19
3.3.2. RoHS compliance	19
3.4. Operating Frequency	19
3.5. Transmitter output power	20
3.6. Receiver(s) sensitivity	20
3.6.1. Cellular sensitivity (all modules)	20
3.6.2. GPS sensitivity (GE864-GPS only)	20
3.7. Antenna(s)	20
3.7.1. Cellular Antenna	20
3.7.2. GPS Antenna.....	20
3.7.3. Combined GPS+Cellular Antenna	21
3.7.4. GC864 QUAD/PY RF antenna connector	21
3.8. Supply voltage.....	21
3.9. Power consumption	21
3.10. GPS Module Features (GE864-GPS only)	22
3.11. The user interface	22



3.12.	Speech CODEC	23
3.13.	SIM Reader	23
3.14.	SMS	23
3.15.	Real Time Clock and Alarm	23
3.16.	Enhanced Measurement Report	23
3.17.	Data transmission capabilities	23
3.18.	Local security management	24
3.19.	Call control	24
3.20.	Phonebook	24
3.21.	Characters management	24
3.22.	SIM related functions	24
3.23.	Call status indication	24
3.24.	Automatic answer (Voice, Data)	24
3.25.	Supplementary services (SS)	24
3.26.	Acoustic signaling	25
3.27.	Buzzer output	25
3.28.	RF Transmission Monitor (RFTXMON)	25
3.29.	RF Transmission Control	25
3.30.	TTY (Telephone Text)	25
3.31.	Logic level specifications	26
3.32.	Audio	26
3.32.1.	Analog	26
3.32.2.	Digital	26
3.33.	Serial Ports	26
3.34.	Converters	26
3.34.1.	ADC Converter	26
3.34.2.	DAC Converter	26
3.35.	Mounting the modules on your Board	26
3.36.	Packing system	27
4.	Evaluation Kit	28
5.	Software Features	29
5.1.	Easy GPRS Extension	29



- 5.1.1. Overview..... 29
- 5.2. Multisocket.....29
- 5.3. Jamming Detection.....30
 - 5.3.1. Overview..... 30
- 5.4. CMUX.....30
 - 5.4.1. Architecture.....30
 - 5.4.2. Features..... 30
- 5.5. Easy Script Extension - Python interpreter31
 - 5.5.1. Overview..... 31
 - 5.5.2. Python 1.5.2+ Copyright Notice 32
- 5.6. SAP: SIM Access Profile33
 - 5.6.1. Architecture.....33
 - 5.6.2. Implementation features.....33
 - 5.6.3. Remote SIM Message Command Description.....33
- 5.7. Premium FOTA Management (PFM) Service34
 - 5.7.1. FOTA (Firmware Over The Air) 34
- 5.8. eCall Compliance34
- 5.9. AT Commands35
- 6. Conformity Assessment Issues36**
 - 6.1. RoHS Declaration38
 - 6.2. CE Conformity Declaration39
 - 6.3. Notified body statement of opinion.....42
 - 6.4. IC Certificate45
 - 6.5. FCC Certificate48
- 7. SAFETY RECOMMENDATIONS51**
- 8. List of acronyms52**
- 9. Document History.....54**



1. Introduction

1.1. Scope

Scope of this document is giving an overview of the Telit GE/GC864-QUAD V2 and GE864-GPS modules (the modules), which are very small GSM/GPRS modules with data and voice capabilities.

1.2. Audience

This document is intended for customers who are evaluating the GE864-QUAD V2 or GC864-QUAD V2 or GE864-GPS modules.

1.3. Contact Information, Support

For general contact, technical support, to report documentation errors and to order manuals, contact Telit Technical Support Center (TTSC) at:

TS-EMEA@telit.com
TS-NORTHAMERICA@telit.com
TS-LATINAMERICA@telit.com
TS-APAC@telit.com

Alternatively, use:

<http://www.telit.com/en/products/technical-support-center/contact.php>

For detailed information about where you can buy the Telit modules or for recommendations on accessories and components visit:

<http://www.telit.com>

To register for product news and announcements or for product questions contact Telit's Technical Support Center (TTSC).

Our aim is to make this guide as helpful as possible. Keep us informed of your comments and suggestions for improvements.

Telit appreciates feedback from the users of our information.



1.4. Document Organization

This document contains the following chapters:

[“Chapter 1: “Introduction”](#) provides a scope for this document, target audience, contact and support information, and text conventions.

[“Chapter 2: “The GE864-QUAD V2\GPS and GC864-QUAD V2”](#) gives an overview of the features of the product.

[“Chapter 3: “Product Description”](#) describes in details the characteristics of the product.

[“Chapter 4: “Evaluation Kit”](#) provides some basic information about the Evaluation Kit.

[“Chapter 5: “Software Features”](#) provides an overview of the software features of the products.

[“Chapter 6: “Conformity Assessment Issues”](#) provides some fundamental hints about the conformity assessment that the final application might need.

[“Chapter 7: “Safety Recommendation”](#) provides some safety recommendations that must be follow by the customer in the design of the application that makes use of the GEGC864 family.

1.5. Text Conventions



Danger – This information MUST be followed or catastrophic equipment failure or bodily injury may occur.



Caution or Warning – Alerts the user to important points about integrating the module, if these points are not followed, the module and end user equipment may fail or malfunction.



Tip or Information – Provides advice and suggestions that may be useful when integrating the module.

All dates are in ISO 8601 format, i.e. YYYY-MM-DD.



1.6. Related Documents

- GC864 Hardware User Guide, 1vv0300841
- GE864 Hardware User Guide, 1vv0300875
- Software User Guide, 1vv0300784
- AT Command User Guide, 80000ST10025a
- CMUX User Guide, 30268ST10299A
- SAP User Guide, 80000ST10029a
- Easy Script User Guide, 80000ST10020a
- Audio Settings Application Note, 80000NT10007a
- Event Monitor Application Note, 80000NT10028a
- IP Easy User Guide, 80000ST10028
- Digital Voice Interface Application Note, 80000nt10004a
- EVK2 User Guide, 1vv0300704
- PFM Application Note, 80000nt10013a



2. The GE864-QUAD V2\GPS and GC864-QUAD V2

2.1. Products Overview

The GE864-QUAD V2 and GC864-QUAD V2 extend Telit range of products, incorporating a single-chip solution built on 0.13 μm CMOS technology into a 30 x 30 x 3 mm block and 36.2 x 30 x 3.2 mm respectively.

The GE864-QUAD V2 is a low cost connector-less top-notch solution for medium to high quantity projects.

The GE864-GPS is the smallest GSM/GPRS module in the market integrating full 48-channel A-GPS functionality. It combines the high performance from Telit's proven GSM/GPRS core technology with the latest SiRFstarIV™ high sensitivity single-chip A-GPS receiver.

Moreover the Telit GE864-GPS is compliant with eCall European Directive.

The low profile and small size of the unique BGA package for the GE864-QUAD V2 enables the design of extremely compact applications. Since connectors are eliminated, the solution cost is significantly reduced compared to conventional mounting.

The GC864-QUAD V2 is provided with an 80-pin Molex board-to-board connector and a 50 Ohm Murata RF connector. It has the same performance as GE864-QUAD V2.

The GC864-QUAD V2 with SIM holder has an integrated SIM holder on the board and identical technical characteristics as the classic GC864-QUAD V2.

With their ultra-compact design and extended temperature range, these products are the perfect platform for high-volume m2m applications and mobile data devices. Additional features such as integrated TCP/IP protocol stack and serial multiplexer extend the functionalities of the application at no additional cost. Moreover, The GPS receiver of GE864-GPS features an extremely low power consumption adaptive micropower controller to maintain hot start capability, a position resolution accuracy of less than 2.5m, Satellite Based Augmentation System (WAAS, EGNOS, MSAS and GAGAN) as well as assisted GPS

They make it possible to run the customer's application inside the module using Python Script Interpreter, thus making it a complete platform for m2m solutions.

These modules support Over-the-Air firmware update by means of Premium FOTA Management. By embedding the RedBend vCurrent Mobile® agent, a proven and battle-tested technology powering hundreds of millions of cellular handsets world-wide, Telit is able to update its products by transmitting only a delta file, which represents the difference from one firmware version to another.

2.2. Target Market

These modules are designed and developed for the usage in applications such as:



- Telemetry
- Telematics
- Tracking and tracing
- Security alarms
- Automated Meter Reading (AMR)
- POS terminals
- PDAs and Mobile Computing
- Automotive and Fleet Management applications

2.3. Product Features

- Quad-band EGSM 850 / 900 / 1800 / 1900 MHz GSM/GPRS protocol stack 3GPP Release 4 compliant
- Output power
 - Class 4 (2W) @ 850 / 900 MHz
 - Class 1 (1W) @ 1800 / 1900 MHz
- Control via AT commands according to 3GPP 27.005, 27.007 and Telit custom AT commands
- Control via Remote AT commands
- Event Monitor engine (ref: Event Monitor Application note)
- Power consumption (typical values)
 - Power off: < 62 uA
 - Idle (registered, power saving): 1.5 mA @ DRX=9
 - Idle (registered, power saving, GPS Hibernate): 1.55 mA @ DRX=9 (only GE864-GPS)
- Serial port multiplexer 3GPP 27.010
- SIM Application Toolkit 3GPP TS 51.014 supporting UCS2 character set
- SIM Access Profile
- eCall Compliant (GE864-GPS only)
- Extended Supply voltage range: 3.22 – 4.5 V DC (3.8 V DC nominal)
- TCP/IP stack access via AT commands
- Sensitivity:
 - - 107 dBm (typ.) @ 850 / 900 MHz
 - - 106 dBm (typ.) @ 1800 / 1900 MHz
- GPS Sensitivity (only) :



- up to 163 dBm in TrackingDARP/SAIC support
- Enhanced Measurement Report support
- Dimensions: 30 x 30 x 3 mm
- Weight:
 - GE864-QUAD V2\GPS 4,2 grams
 - GC864-QUAD V2: 4.8 grams
- Extended temperature range
 - 40°C to +85°C (operational)
 - 40°C to +85°C (storage temperature)
- RoHS compliant
- AT interface on both serial ports
- Added PCM voice signal on UART
- Enhanced AT Commands suite (FTP additional commands, Command mode TCP)

Interfaces

- 10 I/O ports maximum
- Analog audio (balanced)
- Digital Voice Interface
- 2 A/D plus 1 D/A converters
- Buzzer output
- GPS data serial port (GE864-GPS only)
- PPS signal (GE864-GPS only)
- ITU-T V.24 serial link through CMOS UART:
 - Baud rate from 300 to 115.200 bps
 - Autobauding up to 115.200 bps

Audio

- Telephony, emergency call
- Half rate, full rate, enhanced full rate and adaptive multi rate voice codecs (HR, FR, EFR, AMR)
- Superior echo cancellation & noise reduction
- Multiple audio profiles pre-programmed and fully configurable by means of AT commands (ref.: Audio Settings Application Note)



- DTMF

Approvals

- Fully type approved conforming with R&TTE directive
- CE, GCF, FCC, PTCRB, IC

SMS

- Point-to-point mobile originated and mobile terminated SMS
- Concatenated SMS supported
- SMS cell broadcast
- Text and PDU mode
- SMS over GPRS

Circuit switched data transmission

- Asynchronous non-transparent CSD up to 9.6 kbps
- V.110

GPRS data

- GPRS class 10
- Mobile station class B
- Coding scheme 1 to 4
- PBCCH support
- GERAN Feature Package 1 support (NACC, Extended TBF)

GSM Supplementary Services

- Call forwarding
- Call barring
- Call waiting & call hold
- Advice of charge
- Calling line identification presentation (CLIP)
- Calling line identification restriction (CLIR)
- Unstructured supplementary services mobile originated data (USSD)
- Closed user group



Additional features

- SIM phonebook
- Fixed dialling number (FDN)
- Real Time Clock
- Alarm management
- Network LED support
- IRA, GSM, 8859-1 and UCS2 character sets
- Jamming detection
- Embedded TCP/IP stack, including TCP, IP, UDP, SMTP, ICMP and FTP protocols
- EASY SCAN ® automatic scan over GSM frequencies (also without SIM card)

Python* application resources

- Python* script interpreter (module takes the application code directly in the Python* language)
- Memory: 1.9 MB of NV memory for the user scripts and 1 MB RAM for the Python* engine usage
- Over-the-air application SW update
- Script execution speed increased up to 4 times compared to the GE864-QUAD

[*]Copyright © 1991–1995 by Stichting Mathematisch Centrum, Amsterdam, The Netherlands; All Rights Reserved.

Copyright © 1995–2001 Corporation for National Research Initiatives; All Rights Reserved.

Copyright © 2001–2009 Python Software Foundation; All Rights Reserved.

All Rights Reserved are retained in Python.



3. Product Description

3.1. Size and 2D mechanical drawing

The Telit GE864-QUAD V2\GPS module overall dimensions are:

- Length: 30 mm
- Width: 30 mm
- Thickness: 3 mm

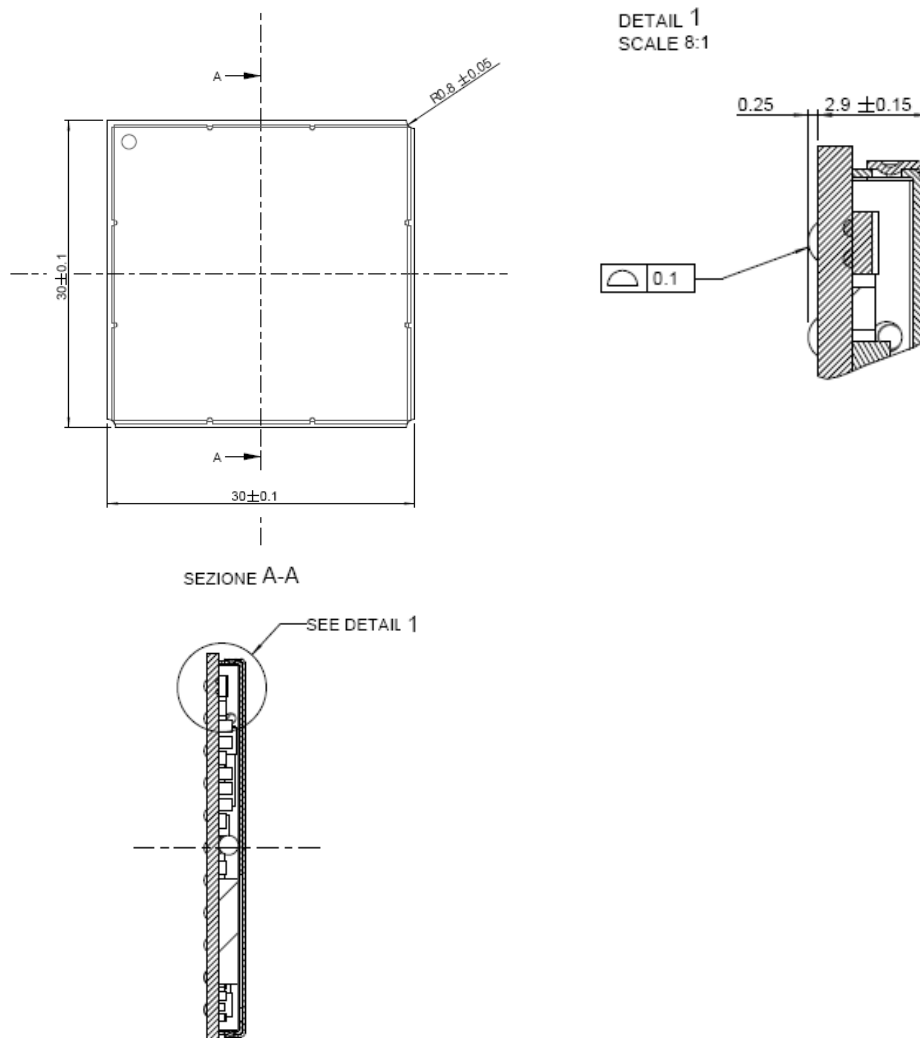

The Telit GC864-QUAD V2 module overall dimensions are:

- Length: 36.2 mm
- Width: 30 mm
- Thickness: 3.2 mm

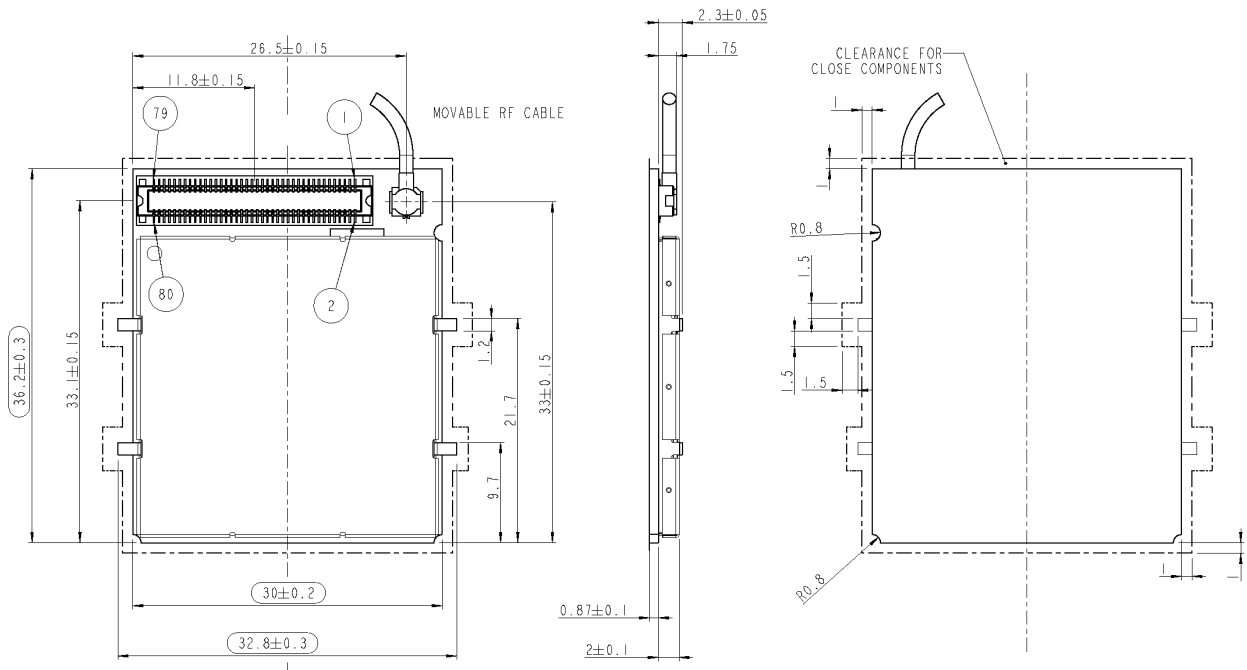

3.1.1. Mechanical View of Telit GC864-QUAD V2 with SIM Holder

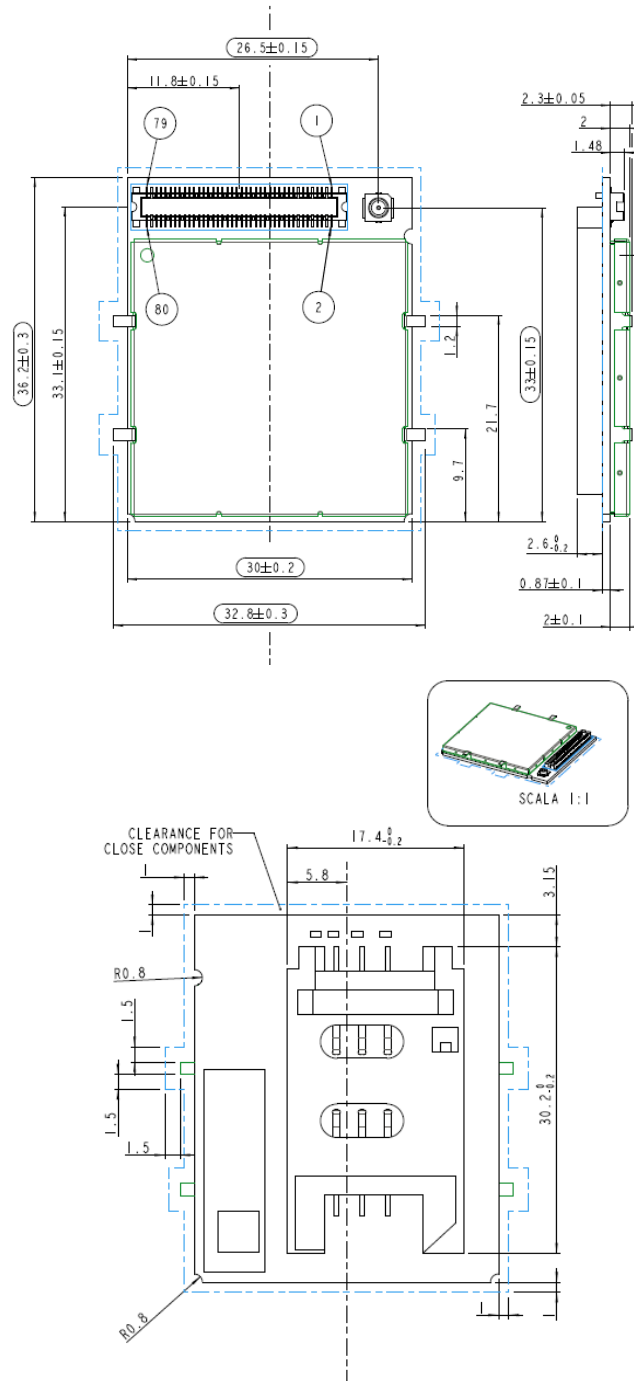

3.2. Weight

The weight of the GE864-QUAD V2\GPS is 4.2 grams.

The weight of the GC864-QUAD V2 is 4.8 grams

3.3. Environmental requirements

3.3.1. Temperature range

		Note
Operating Temperature Range	-20°C ÷ +55°C	The module is fully functional(*) in all the temperature range, and it fully meets the 3GPP specifications.
	-40°C ÷ +85°C	The module is fully functional (*) in all the temperature range.
Storage and non operating Temperature Range	-40°C ÷ +85°C	

(*)Functional: the module is able to make and receive voice calls, data calls, SMS and make GPRS traffic.

3.3.2. RoHS compliance

As a part of Telit corporate policy of environmental protection, the modules comply to the RoHS (Restriction of Hazardous Substances) directive of the European Union (EU Directive 2002/95/EG).

3.4. Operating Frequency

The operating frequencies in GSM, DCS, PCS modes are conform to the GSM specifications.

Mode	Freq. TX (MHz)	Freq. RX (MHz)	Channels (ARFC)	TX - RX offset
GSM 850	824.2÷848.8	869.2÷893.8	124 ÷ 251	45 MHz
EGSM 900	890.0 - 914.8	935.0 - 959.8	0 ÷ 124	45 MHz
	880.2 - 889.8	925.2 - 934.8	975 ÷ 1023	45 MHz
DCS-1800	1710.2 - 1784.8	1805.2 - 1879.8	512 ÷ 885	95 MHz
PCS-1900	1850.2 - 1909.8	1930.2 - 1989.8	512 ÷ 810	80 MHz



3.5. Transmitter output power

The modules transceiver modules in GSM–850/900 operating mode is class 4 in accordance with the specifications which determine the nominal 2W peak RF power (+33dBm) on 50 Ohm. In the DCS–1800/PCS–1900 bands, the operating mode is class 1 in accordance with the specifications which determine the nominal 1W peak RF power (+30dBm) on 50 Ohm.

3.6. Receiver(s) sensitivity

3.6.1. Cellular sensitivity (all modules)

Sensitivity of the modules in GSM 850/900 bands is better than –107 dBm (2.4% BER Class II - static channel) in normal operating conditions.

Sensitivity of the modules in GSM 1800/1900 bands is better than –106 dBm (2.4% BER Class II - static channel) in normal operating conditions.

The modules support also the Downlink Advance Receiver Performance (DARP) feature for single antenna interference cancellation (SAIC).

3.6.2. GPS sensitivity (GE864-GPS only)

GPS sensitivity is -148 dBm in acquisition and -163 dBm in tracking @ L1=1575.42 MHz, CA Code.

3.7. Antenna(s)

3.7.1. Cellular Antenna

The antenna that the customer chooses to use should fulfill the following requirements:

Frequency range	Depending by frequency band(s) provided by the network operator, the customer shall use the most suitable antenna for that/those band(s).
Bandwidth	80 MHz in EGSM 900, 70 MHz if GSM 850, 170 MHz in DCS, 140 MHz PCS band

For further information please refer to the respective Hardware User Guide.

3.7.2. GPS Antenna

the external active antenna for a Telit GE864-GPS device must fulfill the following requirements:



Antenna Requirements	
Frequency range	1575.42 MHz (GPS L1)
Bandwidth	± 1.023 MHz
Gain	1.5 dBi < Gain < 4.5 dBi
Impedance	50Ω
Amplification	Typical 25dB (max 27dB)
Supply voltage	Must accept from 3 to 5 V DC
Current consumption	Typical 20mA (40 mA max)

For further information please refer to the respective Hardware User Guide.

3.7.3. Combined GPS+Cellular Antenna

The use of combined GPS antennas is NOT recommended; this solution could generate an extremely poor GPS reception and also the combination antenna requires additional diplexer and adds a loss in the RF route.

3.7.4. GC864 QUAD/PY RF antenna connector

The GC864-QUAD V2 module is equipped with a 50 Ohm RF connector from Murata, GSC type P/N MM9329-2700B. The suitable counterpart is Murata MXTK92 Type or MXTK88 Type.

Moreover, the GC864-QUAD V2 has the antenna pads on the back side of the PCB. This allows the manual soldering of the coaxial cable directly on the back side of the PCB. However, the soldering is not an advisable solution for a reliable connection of the antenna.

3.8. Supply voltage

The external power supply must be connected to VBATT signal and must fulfill the following requirements:

Nominal Supply Voltage	3.8 V
Normal Operating Voltage Range	3.4 V – 4.2 V
Extended Operating Voltage Range (*)	3.22 V – 4.5 V

(*) Please refer to the respective Hardware User Guide for using the product with the extended operating voltage range.

3.9. Power consumption

The current consumptions of the modules in power-off and idle are:



Power off current typical (RTC running)	< 62 μ A;
Idle registered, power saving	1.6 mA @ DRX=9 (AT+CFUN=5)
Idle registered, power saving, GPS ON (only for GE864-GPS)	xx mA @ DRX=9 (AT+CFUN=5)

Please check the respective HW User Guide for further details about all other power consumption figures.

3.10. GPS Module Features (GE864-GPS only)

The GE864-GPS includes a SiRFstarIV™ single chip GPS receiver, that supports real-time location in urban area and wherever a high sensitivity acquisition is needed. As main features of such GPS receiver, we can mention:

- High sensitivity for indoor reception, up to -163dBm (with active antenna)
- Active Jammer remover
- Time to First Fix (autonomous):
 - Hot Start : 1s
 - Warm Start: <35s
 - Cold Start: <35s
- Supports 48-Channel GPS L1 1575.42 MHz
- Accuracy < 2.5m
- GPS NMEA 0183 output format
- Date WGS-84
- Dedicated GPS AT commands
- SBAS (WAAS,MSAS, GAGAN and EGNOS) support
- Assisted-GPS
- PPS signal
- Low power consumption

3.11. The user interface

The user interface is managed by AT commands according to ITU-T V.250, 3GPP 27.007 and 27.005 specifications. Moreover, custom AT commands are also available. Please refer to the AT Command User Guide for details.



3.12. Speech CODEC

The modules support the following voice codec:

- HR - Half Rate
- FR - Full Rate
- EFR - Enhanced Full Rate
- AMR-HR, AMR Half Rate
- AMR-FR, AMR Full Rate

3.13. SIM Reader

The modules support phase 2 SIM at 1.8V and 3V ONLY with an external SIM connector. For 5V SIM, an external level translator can be added.

3.14. SMS

The modules support the following SMS types:

- Mobile Terminated (MT) class 0 – 3 with signaling of new incoming SMS, SIM full, SMS read
- Mobile Originated class 0 – 3 with writing, saving in SIM and sending
- Cell broadcast compatible with CB DRX with signaling of new incoming SMS.

The modules also support SMS over GPRS

3.15. Real Time Clock and Alarm

The modules support the Real Time Clock and Alarm functions through AT commands. An alarm output pin can be configured to indicate the alarm with a hardware line output.

Furthermore the Voltage Output of the RTC power supply is provided so that a backup capacitor can be added externally to increase the RTC autonomy.

3.16. Enhanced Measurement Report

The modules support the Enhanced Measurement Report on SACCH channel according to 3GPP TS 44.018 version 4.22.0 Release 4 (par. 3.4.1.2, 9.1.54, 9.1.55) and 3GPP TS 45.008 version 4.17.0 Release 4 (par. 8.4.8).

3.17. Data transmission capabilities

The modules are mobile stations class B supporting GPRS Class 10, coding schemes 1 to 4 and PBCCH. Moreover, they support GERAN feature package 1, which consist in supporting the Extended Uplink TBF and Network Assisted Cell Change (NACC).

As for circuit switched data, the modules support asynchronous non-transparent data up to 9.6 Kbps. Moreover, it supports the V.110.



3.18. Local security management

The local security management can be done with the lock of Subscriber Identity module (SIM). The security code will be requested at power-up.

3.19. Call control

The call cost control function is supported.

3.20. Phonebook

This function allows the storing of the telephone numbers in SIM memory. The capability depends on SIM version and its embedded memory.

3.21. Characters management

The modules support the IRA, GSM, 8859-1 and UCS2 characters sets, in TEXT and PDU mode.

3.22. SIM related functions

Fixed Dialing Numbers (FDN), Abbreviated Dialing Number (ADN) and PIN insertion are supported

Extension at the PIN2 for the PUK2 insertion capability for lock condition is supported too.

3.23. Call status indication

The call status indication is supported.

3.24. Automatic answer (Voice, Data)

The automatic answer is supported. The user/application can specify the number of rings after which the module will automatically answer.

The user/application can set the number of rings by means of the command `ATS0=<n>`.

3.25. Supplementary services (SS)

The following supplementary services are supported:

- Call Barring,
- Call Forwarding,
- Calling Line Identification Presentation (CLIP),
- Calling Line Identification Restriction (CLIR),
- Call Waiting, other party call Waiting Indication,
- Call Hold, other party Hold / Retrieved Indication,
- Closed User Group supplementary service (CUG),



- Advice of Charge,
- Unstructured SS Mobile Originated (MO)

3.26. Acoustic signaling

The acoustic signaling of the modules on the selected acoustic device are the following:

- Call waiting;
- Ringing tone;
- SMS received tone;
- Busy tone;
- Power on/off tone;
- Off Hook dial tone;
- Congestion tone;
- Connected tone;
- Call dropped;
- No service tone;
- Alarm tone.

3.27. Buzzer output

A general purpose I/O pin can be configured to output the BUZZER output signal. With an external MOSFET or transistor and a diode, a buzzer can be directly driven.

The ringing tone and the other signaling tones can be redirected to this buzzer output with a specific AT command.

3.28. RF Transmission Monitor (RFTXMON)

As alternate function of the GPIO5, the modules can provide the RF transmission monitor. When the alternate function is activated, the pin of GPIO5 changes to HIGH every time the module transmits an RF signal and remains HIGH for the duration of the transmission sequence, i.e. it does not change with every GSM signal burst.

3.29. RF Transmission Control

As alternate function of the GPIO4 pin, when configured as RF Transmission Control Input, it allows to disable the Transmitter when the GPIO is set to Low by the application.

3.30. TTY (Telephone Text)

The TTY feature is supported. Please refer to 3GPP TS 26.226 and 3GPP TS 26.231 for details.



3.31. Logic level specifications

Where not specifically stated, all the interface circuits work at 2.8V CMOS logic levels. To get more detailed information about the logic level specifications used in the modules, please check with the respective Hardware User Guide.

3.32. Audio

3.32.1. Analog

The modules offer one audio line balanced. They have a built-in echo canceller and a noise suppressor. For more details, please refer to the respective Hardware User Guide.

3.32.2. Digital

The modules offer the digital voice interface. For more details, please refer to the Digital Voice Interface Application Note.

3.33. Serial Ports

Two serial ports are available on the module:

- Main serial port (full RS232), auto-bauding up to 115,200 bps
- AUX serial port (RX & TX only), 115,200 bps
- GPS serial port (NMEA 0183 standard)

3.34. Converters

3.34.1. ADC Converter

The modules have two on board ADC, which are 11-bit converter. They are able to read a voltage level in the range of 0÷2 volts applied on the ADC pin input, store and convert it into 11 bit word.

3.34.2. DAC Converter

The modules have one on board DAC, which is a 10 bit converter, able to generate an analogue value based a specific input in the range from 0 up to 1023. However, an external low-pass filter is necessary. See the respective HW User Guide for the details.

3.35. Mounting the modules on your Board

The modules have been designed in order to be compliant with a standard lead-free SMT process. For detailed information about PCB pad design and conditions to use in SMT process please check with the respective Hardware User Guide.



3.36. Packing system

The modules are supplied on trays of 50 pieces each. Moreover, the GE864-QUAD V2\GPS is also available in Tape&Reel of 200 pcs a reel.



4. Evaluation Kit

In order to assist the customer in the development of the application, Telit offers the EVK2 Evaluation Kit that can be ordered separately. The EVK2 has a SIM card holder, the RS 232 serial port level translator, a direct UART connection, audio and antenna connector.

The EVK2 provides a fully functional solution for a complete data or phone application. The standard serial RS232 9 pin connector placed on the Evaluation Kit allows the connection of the EVK2 system with a PC or other DTE.

The development of the applications utilizing the Telit module must present a proper design of all the interfaces towards and from the module (e.g. power supply, audio paths, level translators), otherwise a decrease in the performances will be introduced or, in the worst case, a wrong design can even lead to an operating failure of the module.

In order to assist the hardware designer in his project phase, the EVK2 board presents a series of different solutions, which will cover the most common design requirements on the market, and which can be easily integrated in the OEM design as building blocks or can be taken as starting points to develop a specific one.

For a detailed description of the Telit Evaluation Kit, please refer to the documentation provided with the respective Hardware User Guide and EVK2 User User Guide.



5. Software Features

5.1. Easy GPRS Extension

5.1.1. Overview

The Easy GPRS feature allows the modules user to contact a device in internet and establish with it a raw data flow over the GPRS and Internet networks.

This feature can be seen as a way to obtain a "virtual" serial connection between the Application Software on the Internet machine involved and the controller of the modules, regardless of all the software stacks underlying.

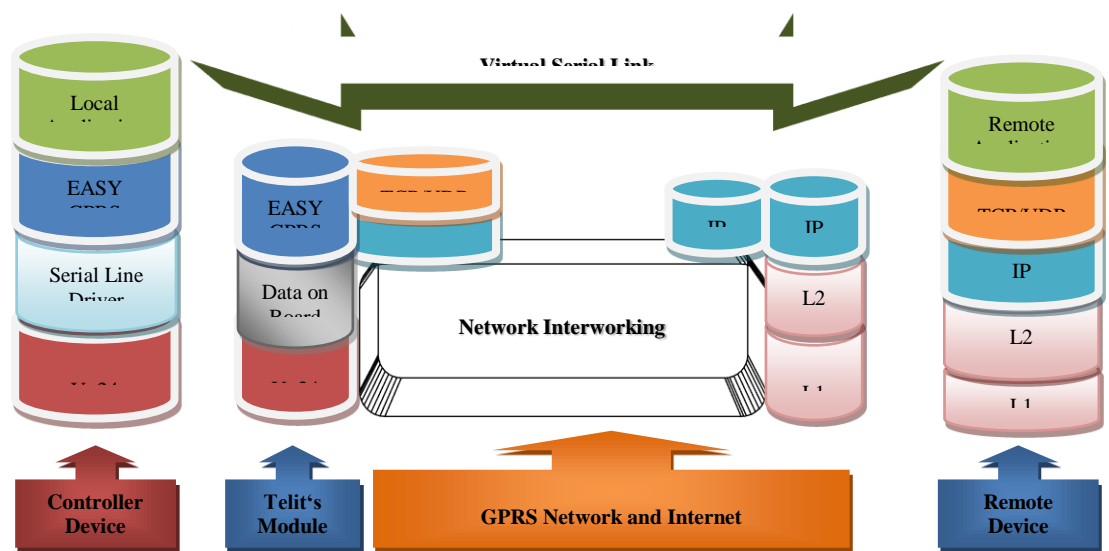

This particular implementation allows to the devices interfacing to the modules the use of the GPRS and Internet packet service without the need to have an internal TCP/IP stack since this function is embedded in the module.

For more detailed information regarding the use of the Easy GPRS feature, please consult Easy GPRS User Guide and AT Commands Reference Guide.

5.2. Multisocket

The multisocket is an extension of Telit Easy GPRS feature, which allows the user to have two contexts activated (that means two different IP address), more than one socket connection (with a maximum of 6) and simultaneous FTP client service.

For more detailed information please consult the Easy GPRS User Guide.



5.3. Jamming Detection

5.3.1. Overview

The Jammed Detect feature allows the modules to detect the presence of a disturbing device such as a Communication Jammer and give indication to the user.

This feature can be very important in alarm, security and safety applications that rely on the module for the communications. In these applications, the presence of a Jammer device can compromise the whole system reliability and functionality and therefore shall be recognized and reported to the local system for countermeasure actions.

5.4. CMUX

CMUX (Converter-Multiplexer) is a multiplexing protocol implemented in the modules that can be used to send any data, SMS, or TCP data.

5.4.1. Architecture

The Multiplexer mode enables one serial interface to transmit data to four different customer applications. This is achieved by providing four virtual channels using a Multiplexer (MUX).

This is especially advantageous when a data/GPRS call is ongoing. Using the Multiplexer features, e.g. controlling the module or using the SMS service can be done via the additional channels without disturbing the data flow; access to the second UART is not necessary.

Furthermore, several accesses to the module can be created with the Multiplexer. This is of great advantage when several independent electronic devices or interfaces are used.

To access the three virtual interfaces, both the GSM engine and the customer application must contain MUX components, which communicate over the multiplexer protocol.

In Multiplexer mode, AT commands and data are encapsulated into packets. Each packet has channel identification and may vary in length.

5.4.2. Features

- 3GPP 27.010 CMUX Basic Option used
- CMUX implementation support four full DLCI (Serial Port)
- Every CMUX instance has its own user profile storage in NVM
- Independent setting of unsolicited message.
- Every CMUX instance has its own independent flow control



NOTE:

More details about the Multiplexer mode are available in the CMUX User Guide.



5.5. Easy Script Extension - Python interpreter

5.5.1. Overview

The Easy Script Extension is a feature that allows driving the modem "internally", writing the controlling application directly in a nice high level language: Python.

The Easy Script Extension is aimed at low complexity applications where the application was usually done by a small microcontroller that managed some I/O pins and the module through the AT command interface.

A schematic of such a configuration can be:

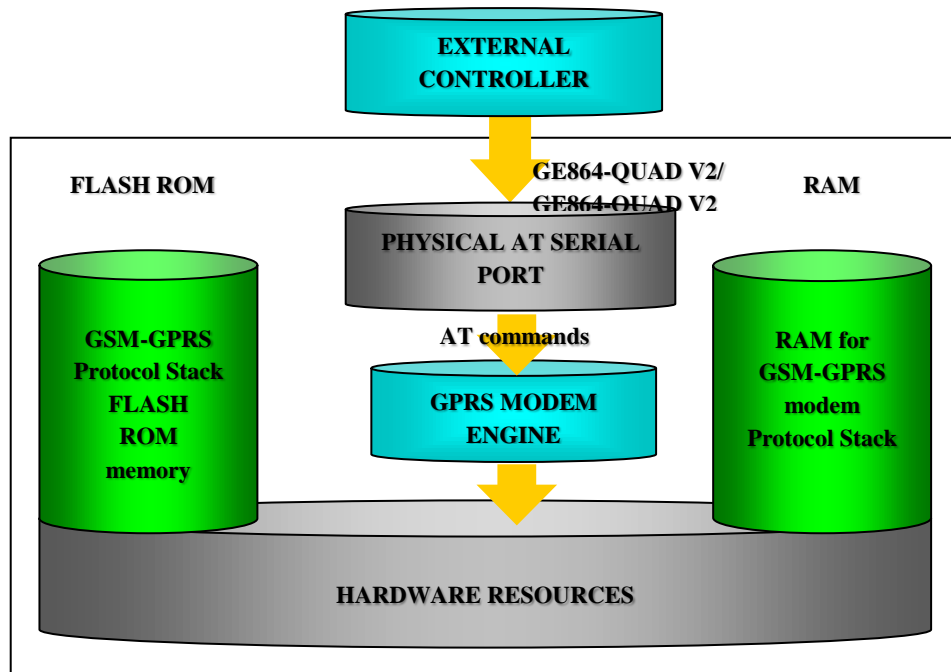

In order to not use any external controller, and further simplify the programming of the sequence of operations, the customer can benefit of these feature already embedded in the modules:

- Python script interpreter engine v. 1.5.2+
- 1.9 MB of Non Volatile Memory room for the user scripts and data
- 1 MB RAM reserved for Python engine usage



5.5.2. Python 1.5.2+ Copyright Notice

The Python code implemented into the Telit module is copyrighted by Stichting Mathematisch Centrum, this is the license:

Copyright © 1991-1995 by Stichting Mathematisch Centrum, Amsterdam, The Netherlands.
All Rights Reserved

Copyright (c) 1995-2001 Corporation for National Research Initiatives; All Rights Reserved.

Copyright (c) 2001, 2002, 2003, 2004 Python Software Foundation; All Rights Reserved.

Copyright (c) 2001-2008 Python Software Foundation; All Rights Reserved.

All Rights Reserved are retained in Python.

Permission to use, copy, modify, and distribute this software and its documentation for any purpose and without fee is hereby granted, provided that the above copyright notice appear in all copies and that both that copyright notice and this permission notice appear in supporting documentation, and that the names of Stichting Mathematisch Centrum or CWI or Corporation for National Research Initiatives or CNRI not be used in advertising or publicity pertaining to distribution of the software without specific, written prior permission.

While CWI is the initial source for this software, a modified version is made available by the Corporation for National Research Initiatives (CNRI) at the Internet address <ftp://ftp.python.org>.

STICHTING MATHEMATISCH CENTRUM AND CNRI DISCLAIM ALL WARRANTIES WITH REGARD TO THIS SOFTWARE, INCLUDING ALL IMPLIED WARRANTIES OF MERCHANTABILITY AND FITNESS, IN NO EVENT SHALL STICHTING MATHEMATISCH CENTRUM OR CNRI BE LIABLE FOR ANY SPECIAL, INDIRECT OR CONSEQUENTIAL DAMAGES OR ANY DAMAGES WHATSOEVER RESULTING FROM LOSS OF USE, DATA OR PROFITS, WHETHER IN AN ACTION OF CONTRACT, NEGLIGENCE OR OTHER TORTIOUS ACTION, ARISING OUT OF OR IN CONNECTION WITH THE USE OR PERFORMANCE OF THIS SOFTWARE.



NOTE:

More details about the Python modules are available in the Easy Script in Python User Guide.



5.6. SAP: SIM Access Profile

5.6.1. Architecture

The SAP feature allows the module to use the SIM of a remote SIM Server. This feature is implemented using special AT Command on a Virtual circuit of the CMUX interface.

5.6.2. Implementation features

- SAP is based on 3GPP 27.010 CMUX Basic Option used
- Only SAP Client features
- Logic HW flow control is recommended on the Virtual instance selected for the SAP command.

5.6.3. Remote SIM Message Command Description

The module sends request commands to the client application through a binary message that is crowned in the CMUX message. The client application shall extract the message and send it to the SAP server, through the appropriate protocols (e.g. by RFCOMM, that is the Bluetooth serial port emulation entity).

The client application shall extract all the messages sent by SAP server and put them in the CMUX message, to be sent to the module.

The module fulfills the following feature requirements:

- Connection management
- Transfer APDU
- Transfer ATR
- Power SIM on
- Report Status
- Error Handling



Every feature needs some procedures support:

Feature	Procedure
Connection Management	Connect
	Report Status
	Transfer ATR
	Disconnection Initiated by the Client
	Disconnection Initiated by the Server
Transfer APDU	Transfer APDU
Transfer ATR	Transfer ATR
Power SIM on	Power SIM on
	Transfer ATR
Report Status	Report Status
Error Handling	Error Response

Report Status, Disconnection Initiated by the Server and Error Response are independent messages sent by server. The other procedures consist of couples of messages, started by client.



NOTE:

More details about the SAP are available in the SAP User Guide.

5.7. Premium FOTA Management (PFM) Service

The premium FOTA Management Service provides a cost-effective, fast, secure and reliable way for wirelessly reflashing the firmware on mobile devices, ensuring that embedded software is up-to-date with the latest enhancements and features.

Customers, who want to benefit from this service, must pass through the Telit certification program, where Telit will assist the customer in validating the correct implementation of FOTA.

5.7.1. FOTA (Firmware Over The Air)

Telit, which has signed a partnership agreement with the worldwide leader of Firmware OTA technology Red Bend, has integrated its unique vCurrent® Mobile client software for use in its m2m product portfolio. Telit is therefore able to upgrade its products by transmitting only a delta file, which represents the difference between one firmware version and another.

See “PFM Application Note” for details in www.telit.com > Product > GSM/GPRS > Product Family > Application Notes.

5.8. eCall Compliance

eCall is a project of the European Commission intended to bring rapid assistance to motorists involved in a collision anywhere in the European Union. The projects aims to employ a hardware black box installed in vehicles that will wirelessly send vehicle location



information, time stamp, number of passengers, Vehicle Identification Number (VIN), and other relevant accident information to local emergency agencies eCall builds on emergency voice call (E112).

The main actors are the IVS (In-Vehicle System) and the PSAP (Public Safety Answering Point). When a collision happens the IVS sends to PSAP the MSD (Minimum Set of Data) via the speech channel of cellular and PSTN networks.

eCall provides reliable full-duplex data communications between IVS and PSAP in addition to emergency voice call, and can be initiated either automatically or manually. The eCall In-band Modem uses the same voice channel as used for the emergency voice call. eCall allows reliable transmission of MSD alternating with a speech conversation through the existing voice communication paths in cellular mobile phone systems.

Telit, understanding the importance of the eCall standard, developed its own eCall in band modem solution. The extra-rugged GE864-QUAD Automotive V2 is able to act as IVS in-band modem.

IVS in-band modem functionality is completely transparent because user has only to enable it and manage unsolicited messages coming for AT commands interface.

For a complete description of Telit's eCall solution, please refer to TELIT Solution for eCall Testing Application Note, 80000NT10046a.

5.9. AT Commands

The modules can be driven via the serial interface using the standard AT commands.

The modules are compliant with:

1. Hayes standard AT command set, in order to maintain the compatibility with existing SW programs.
2. 3GPP 27.007 specific AT command and GPRS specific commands.
3. 3GPP 27.005 specific AT commands for SMS (Short Message Service) and CBS (Cell Broadcast Service)

Moreover the modules support also Telit proprietary AT commands for special purposes.

For a more information about AT commands supported by the modules please refer to document AT Commands Reference Guide.



6. Conformity Assessment Issues

The modules have been assessed in order to satisfy the essential requirements of the R&TTE Directive 1999/05/EC (Radio Equipment & Telecommunications Terminal Equipments) to demonstrate the conformity against the harmonized standards with the final involvement of a Notified Body.

CE 0889

By using our certified module, the evaluation under Article 3.2 of the R&TTE is considerably reduced, allowing significant savings in term of cost and time in the certification process of the final product.

In all cases the assessment of the final product must be made against the Essential requirements of the R&TTE Directive Articles 3.1(a) and (b), Safety and EMC respectively, and any relevant Article 3.3 requirements.

This Product Description, the Hardware User Guide and Software User Guide contain all the information you may need for developing a product meeting the R&TTE Directive.

Furthermore the modules are FCC Approved as module to be installed in other devices. This device is to be used only for fixed and mobile applications. If the final product after integration is intended for portable use, a new application and FCC is required.

The modules are conforming to the following US Directives:

- Use of RF Spectrum. Standards: FCC 47 Part 24 (GSM 1900)
- EMC (Electromagnetic Compatibility). Standards: FCC47 Part 15

This device complies with Part 15 of the FCC Rules. Operation is subject to the following two conditions:

- (1) this device may not cause harmful interference, and
- (2) this device must accept any interference received, including interference that may cause undesired operation.



To meet the FCC's RF exposure rules and regulations:

- The system antenna(s) used for this transmitter must be installed to provide a separation distance of at least 20 cm from all the persons and must not be co-located or operating in conjunction with any other antenna or transmitter.
- The system antenna(s) used for this module must not exceed 1.4dBi (850MHz) and 3.0dBi (1900MHz) for mobile and fixed or mobile operating configurations.
- Users and installers must be provided with antenna installation instructions and transmitter operating conditions for satisfying RF exposure compliance.

Manufacturers of mobile, fixed or portable devices incorporating this module are advised to clarify any regulatory questions and to have their complete product tested and approved for FCC compliance.



6.1. RoHS Declaration



DECLARATION OF EU RoHS Compliance

We **Telit Communications S.p.A**

Of: **Via Stazione di Prosecco, 5/b
34010 Sgonico (TRIESTE)
ITALY**

declare under our sole responsibility that the family product:

**GC864-QUAD V2, GC864-DUAL V2,
GE864-QUAD V2, GE864-QUAD DS V2, GE864-DUAL V2,
GE864-QUAD Automotive, GE864-QUAD ATEX**

to which this declaration relates, is in compliance with EU Directive 2002/95/EC on restriction of the use of certain hazardous substances in electrical and electronic equipment (RoHS), subsequent amendments, and to the European Court of Justice decision on Deca-BDE substances from July 1, 2008.

This information represents Telit's knowledge and belief as of the date that is provided. Telit bases its material composition content knowledge on the test performed on the family product (report No.CANEC1002845701 of SGS-CSTC Standards Technical Services Co., Ltd. Shekou Branch - PRC, laboratory issued on 13 July 2010) and RoHS conformity declarations issued by third party (components suppliers). Telit continues to take commercially reasonable steps to provide representative and accurate information, but may not have conducted chemical analysis on incoming materials and chemicals in the manufacturing sites.

The technical documentation or other information showing that electrical and electronic equipment which has put on the market, complies the requirements of the Directive is held at:

Telit Communications S.p.A
Via Stazione di Prosecco, 5/b
34010 Sgonico (TRIESTE)
ITALY

Trieste July 13, 2010

 Antonino Sgroi
R&D Head

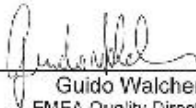
 Guido Walcher
EMEA Quality Director



6.2. CE Conformity Declaration

<h3>DECLARATION OF CONFORMITY</h3>	
<p>We, Telit Communications S.p.A</p>	
<p>Of: Via Stazione di Prosecco, 5/b 34010 Sgonico (TRIESTE) ITALY</p>	
<p>declare under our sole responsibility that the product:</p>	
<p>GC864-QUAD V2 and the derived family product GC864-QUAD SH V2 Quad Band GSM850/EGSM900/DCS1800/PCS1900 GPRS Modules</p>	
<p>to which this declaration relates is in conformity with all the essential requirements of the European Directive 1999/05/EC (R&TTE).</p>	
<p>The conformity with the essential requirements of the European Directive 1999/05/EC has been demonstrated against the following harmonized standard:</p>	
RF spectrum use (R&TTE art. 3.2)	EN 301 511 v9.0.2 (2003-03)
<p>The module has also been verified as a module against the following harmonized standards:</p>	
EMC (R&TTE art. 3.1b)	EN 301 489-1 v1.8.1 (2008-04); -7 v1.3.1 (2005-11)
Health & Safety (R&TTE art. 3.1a)	EN 60950-1:2006
<p>The conformity assessment procedure referred to in Article 10 and detailed in Annex IV of Directive 1999/5/EC has been followed with the involvement of the following Notified Body Notified Body for Article 3.2:</p>	
<p>RFI Global Services Ltd. Pavilion A, Ashwood Park, Ashwood way RG23 8BG BASINGSTOKE United Kindom</p>	
<p>RFI File number: RFI-NOTA1-SC76921JD11 dated 08/06/2010 TCF No. 76921JD10 dated 02/06/2010</p>	
Identification mark:	0889
<p>The technical documentation relevant to the above equipment is held at:</p>	
<p>Telit Communications S.p.A Via Stazione di Prosecco, 5/b 34010 Sgonico (TRIESTE) ITALY</p>	
Trieste, 9th June 2010	 _____ 2.5G R&D Director Antonino Sgroi
	 _____ EMEA Quality Director Guido Walcher





DECLARATION OF CONFORMITY

We, **Telit Communications S.p.A**

Of: **Via Stazione di Prosecco, 5/b
34010 Sgonico (TRIESTE)
ITALY**

declare under our sole responsibility that the product:

GE864-QUAD V2

Quad-Band GSM850/EGSM900/DCS1800/PCS1900 GPRS Module

to which this declaration relates is in conformity with all the essential requirements of the European Directive 1999/05/EC (R&TTE).

The conformity with the essential requirements of the European Directive 1999/05/EC has been demonstrated against the following harmonized standard:

RF spectrum efficiency (R&TTE art. 3.2)	EN 301 511 v9.0.2 (2003-03)
---	-----------------------------

The module has also been verified as a module against the following harmonized standards:

EMC (R&TTE art. 3.1b)	EN 301 489-1 v1.6.1 (2005-09); -7 v1.3.1 (2005-11)
Safety (R&TTE art. 3.1a)	EN 60950-1:2006

The conformity assessment procedure referred to in Article 10 and detailed in Annex IV of Directive 1999/5/EC has been followed with the involvement of the following Notified Body for Article 3.2:

RFI Global Services Ltd
Pavilion A, Ashwood Park, Ashwood Way
RG23 8BG BASINGSTOKE
United Kingdom

Identification mark: **0889**

The technical documentation relevant to the above equipment will be held at:

Telit Communications S.p.A
Via Stazione di Prosecco, 5/b
34010 Sgonico (TRIESTE)ITALY

Trieste, **15th December 2009**



EMEA Quality Director
Guido Walcher





EC DECLARATION OF CONFORMITY



1. GE864-GPS (product name)
2. Telit Communications S.p.A Via Stazione di Prosecco, 5/b 34010 Sgonico –TRIESTE- ITALY (manufacturer)
3. This declaration of conformity is issued under the sole responsibility of the manufacturer
4. Quad Band GSM850 / EGSM900 / DCS1800 /PS1900 Module + GPS



5. The object of the declaration described above is in conformity with the relevant Community harmonisation: European Directive 1999/05/EC (R&TTE)
6. The conformity with the essential requirements of the 1999/05/EC has been demonstrated against the following harmonized standard:

EN 301 511 V9.0.2	For article 3.2 : Effective use of spectrum allocated
EN 300 440-2 V.1.4.1	

The product has also been verified against the following harmonized standards:

EN 60950-1:2006 + A11:2009+CORR:2006+A1:2010	For article 3.1 (a): Health and Safety of the User
EN 301 489-1 V1.8.1	
EN 301 489-3 V1.4.1	For article 3.1 (b): Electromagnetic Compatibility
EN 301 489-7 V1.3.1	

7. The conformity assessment procedure referred to in Article 10 and detailed in Annex IV of Directive 1999/05/EC has been followed with the involvement of the following Notified Body for article 3.2:
RFI Global Services Ltd Pavilion A, Ashwood Park, Ashwood Way RG23 8BG BASINGSTOKE United Kingdom
Notified Body Number 0889

Thus, **CE 0889** is placed on the product.

8. The Technical Construction File (TCF) relevant to the product described above and which support this Declaration of Conformity, is held at: Telit Communications S.p.A Via Stazione di Prosecco, 5/b 34010 Sgonico (TRIESTE) ITALY.

Signed for and on behalf of Telit Communications S.p.A
Trieste, 2011-11-18

 Cellular Manager EMEA
Antonino Sgroi

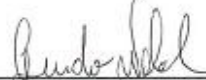
 Quality & IPR Director
Guido Walcher

 Automotive Quality System Manager
Cesare Robelli

Mod 0211 2010-11 Rev.1 (768/2008/EC)



6.3. Notified body statement of opinion

NOTIFIED BODY OPINION



NOTIFIED BODY STATEMENT OF OPINION

(For Council Directive 1999/5/EC)

This opinion is issued to

Telit Communications S.p.A.

Via Stazione di Prosecco 5/B
34010 Sgonico (TS)
Italy

to state that the equipment known as

GE865-QUAD and GE864-QUAD V2 Variants

in our opinion, conforms (following an evaluation of its associated Technical Construction File and subject to any restrictions stated in the attached Annex) with the essential requirements of Annex IV of Council Directive 1999/5/EC on radio equipment and telecommunications terminal equipment and the mutual recognition of their conformity, in relation to the essential requirements of :

Article 3.2 Radio Spectrum.

Details of the scope of this opinion, standards used, RF parameters of this equipment and other information necessary for the correct interpretation and application, including any remarks, restrictions or observations that are detailed in the attached Annex.

Signed:



John Bellairs on behalf of RFI Global Services Ltd.

Issue Date: 17 December 2009

Notified Body
Opinion No: RFI-NOTA1-SC765D6JD02



RFI Global Services Ltd, Pavilion A, Ashwood Park,
Ashwood Way, Basingstoke, Hampshire, RG23 8BG, UK
Tel: +44 (0) 1256 312000 Fax: +44 (0) 1256 312001
Web Address: www.rfi-global.com email: contactus@rfi-global.com

CE0889



NOTIFIED BODY OPINION



NOTIFIED BODY STATEMENT OF OPINION

(For Council Directive 1999/5/EC)

This opinion is issued to

Telit Communications S.p.A.

Via Stazione di Prosecco 5/B
34010 Sgonico (TS)
Italy

to state that the equipment known as

GC864-QUADV2

in our opinion, conforms (following an evaluation of its associated Technical Construction File and subject to any restrictions stated in the attached Annex) with the essential requirements of Annex IV of Council Directive 1999/5/EC on radio equipment and telecommunications terminal equipment and the mutual recognition of their conformity, in relation to the essential requirements of :

Article 3.2 Radio Spectrum.

Details of the scope of this opinion, standards used, RF parameters of this equipment and other information necessary for the correct interpretation and application, including any remarks, restrictions or observations that are detailed in the attached Annex.

Signed:

John Bellini on behalf of RFI Global Services Ltd.

Issue Date: 08 June 2010

Notified Body Opinion No: RFI-NOTA1-SC76921JD11



RFI Global Services Ltd, Pavilion A, Ashwood Park,
Ashwood Way, Basingstoke, Hampshire, RG23 8BG, UK
Tel: +44 (0) 1256 312000 Fax: +44 (0) 1256 312001
Web Address: www.rfi-global.com email: contactus@rfi-global.com

CE0889



NOTIFIED BODY OPINION



NOTIFIED BODY STATEMENT OF OPINION
(For Council Directive 1999/5/EC)

This opinion is issued to

Telit Communications S.p.A
Via Stazione di Prosecco 5/B
34010 Sgonico (TS)
Italy

to state that the equipment known as

GE-864-GPS

in our opinion, conforms (following an evaluation of its associated Technical Construction File and subject to any restrictions stated in the attached Annex) with the essential requirements of Annex IV of Council Directive 1999/5/EC on radio equipment and telecommunications terminal equipment and the mutual recognition of their conformity, in relation to the essential requirements of :

Article 3.2 Radio Spectrum.

Details of the scope of this opinion, standards used, RF parameters of this equipment and other information necessary for the correct interpretation and application, including any remarks, restrictions or observations that are detailed in the attached Annex.

Signed:

John Bellairs on behalf of RFI Global Services Ltd.

Issue Date: 06 October 2011

Notified Body
Opinion No: RFI-NOTA1-SC80007JD11



RFI Global Services Ltd
Pavilion A, Ashwood Park, Ashwood Way, Basingstoke, Hampshire, RG23 8BG
Tel: +44 (0)1256 31 2000 Fax: +44 (0)1256 31 2001
Web: www.rfi-global.com Email: contactus@rfi-global.com

NB nr.0889



6.4. IC Certificate

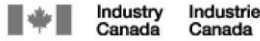

Submission No. > 141635

TECHNICAL ACCEPTANCE CERTIFICATE

CERTIFICAT D'APPROBATION TECHNIQUE

CERTIFICATION No. > **5131A-GE864Q2**
No. DE CERTIFICATION

ISSUED TO > **TELIT COMMUNICATIONS S.p.A.**
DÉLIVRÉ A

TYPE OF EQUIPMENT > **GSM/ GPRS Modem Module**
GENRE DE MATÉRIEL

TRADE NAME AND MODEL > **GE864-QUAD V2**
MARQUE ET MODELE

FREQUENCY RANGE BANDE DE FRÉQUENCES	EMISSION TYPE GENRE D'ÉMISSION	R.F. POWER PUISSANCE H.F.	SPECIFICATION/ ISSUE SPÉCIFICATION/ ÉDITION	
1.8502 to 1.9098 GHz	243KGXW	930.00 mW	RSS133	5
824.2000 to 848.8000 MHz	245KGXW	1.74 W	RSS132	2

Certification of equipment means only that the equipment has met the requirements of the above noted specifications. License applications, where applicable to use certified equipment, are acted on accordingly by the issuing office and will depend on the existing radio environment, service and location of operation.

L'homologation de matériel signifie seulement qu'il est conforme aux exigences du cahier des charges mentionné ci-dessus. Les demandes de licence, le cas échéant en vue de l'utilisation de matériel certifié seront traitées en conséquence par le bureau chargé de délivrer les dites licences, en tenant compte du milieu radioélectrique ambiant, du service radio existant et de l'emplacement de la station.

This certificate is issued on condition that the holder complies and will continue to comply with the requirements of the radio standards specifications and procedures issued by the Department.

Le présent certificat est délivré à la condition que le détenteur se conforme et continue à se conformer aux cahiers des charges et procédures publiées par le ministère.

**ISSUED UNDER THE AUTHORITY OF MINISTER OF INDUSTRY
DÉLIVRÉ AVEC L'AUTORISATION DU MINISTRE DE L'INDUSTRIE**

DATE **July 28 2010**

Nicolas DesMarais

FOR
DIRECTOR GENERAL
ENGINEERING, PLANNING
AND STANDARDS

POUR
DIRECTEUR GÉNÉRAL
DU GÉNIE, DE LA
PLANIFICATION ET
DES NORMES

Canada



Submission No. > 140341

**TECHNICAL ACCEPTANCE
CERTIFICATE**

**CERTIFICAT D'APPROBATION
TECHNIQUE**

CERTIFICATION No.
No. DE CERTIFICATION > **5131A-GC864Q2**

ISSUED TO
DÉLIVRÉ A > **TELIT COMMUNICATIONS S.p.A.**

TYPE OF EQUIPMENT
GENRE DE MATÉRIEL > **GSM/GPRS radio Module**

TRADE NAME AND MODEL
MARQUE ET MODELE > **GC864-QUAD V2**

FREQUENCY RANGE BANDE DE FRÉQUENCES	EMISSION TYPE GENRE D'ÉMISSION	R.F. POWER PUISSANCE H.F.	SPECIFICATION/ ISSUE SPÉCIFICATION/ ÉDITION	
824.2000 to 848.8000 MHz	247KGXW	1.41 W	RSS132	2
1.8502 to 1.9098 GHz	243KGXW	790.00 mW	RSS133	5

Certification of equipment means only that the equipment has met the requirements of the above noted specifications. License applications, were applicable to use certified equipment, are acted on accordingly by the issuing office and will depend on the existing radio environment, service and location of operation.

L'homologation de matériel signifie seulement qu'il est conforme aux exigences du cahier des charges mentionné ci-dessus. Les demandes de licence, le cas échéant en vue de l'utilisation de matériel certifié seront traitées en conséquence par le bureau chargé de délivrer les dites licences, en tenant compte du milieu radioélectrique ambiant, du service radio existant et de l'emplacement de la station.

This certificate is issued on condition that the holder complies and will continue to comply with the requirements of the radio standards specifications and procedures issued by the Department.

Le présent certificat est délivré à la condition que le détenteur se conforme et continue à se conformer aux cahiers des charges et procédures publiées par le ministère.

**ISSUED UNDER THE AUTHORITY OF MINISTER OF INDUSTRY
DÉLIVRÉ AVEC L'AUTORISATION DU MINISTRE DE L'INDUSTRIE**

DATE **April 14 2010**



Nicolas DesMarais

FOR
DIRECTOR GENERAL
ENGINEERING, PLANNING
AND STANDARDS

POUR
DIRECTEUR GÉNÉRAL
DU GÉNIE, DE LA
PLANIFICATION ET
DES NORMES





Industry
Canada

Industrie
Canada

Submission No. > 151605

**TECHNICAL ACCEPTANCE
CERTIFICATE**

**CERTIFICAT D'APPROBATION
TECHNIQUE**

CERTIFICATION No.
No. DE CERTIFICATION > **5131A-GE864G2**

ISSUED TO
DÉLIVRÉ À > **TELIT COMMUNICATIONS S.p.A.**

TYPE OF EQUIPMENT
GENRE DE MATÉRIEL > **GSM/ GPRS Module**

TRADE NAME AND MODEL
MARQUE ET MODELE > **GE864-GPS**

FREQUENCY RANGE BANDE DE FRÉQUENCES	EMISSION TYPE GENRE D'ÉMISSION	R.F. POWER PUISSANCE H.F.	SPECIFICATION/ ISSUE SPÉCIFICATION/ ÉDITION
824.2000 to 848.8000 MHz	246KGXW--	2.45 W	RSS132 2
1.8502 to 1.9098 GHz	246KGXW--	1.66 W	RSS133 5

Certification of equipment means only that the equipment has met the requirements of the above noted specifications. License applications, where applicable to use certified equipment, are acted on accordingly by the issuing office and will depend on the existing radio environment, service and location of operation.

L'homologation de matériel signifie seulement qu'il est conforme aux exigences du cahier des charges mentionné ci-dessus. Les demandes de licence, le cas échéant en vue de l'utilisation de matériel certifié seront traitées en conséquence par le bureau chargé de délivrer les dites licences, en tenant compte du milieu radioélectrique ambiant, du service radio existant et de l'emplacement de la station.

This certificate is issued on condition that the holder complies and will continue to comply with the requirements of the radio standards specifications and procedures issued by the Department.

Le présent certificat est délivré à la condition que le détenteur se conforme et continue à se conformer aux cahiers des charges et procédures publiées par le ministère.

**ISSUED UNDER THE AUTHORITY OF MINISTER OF INDUSTRY
DÉLIVRÉ AVEC L'AUTORISATION DU MINISTRE DE L'INDUSTRIE**

DATE **November 17 2011**



Nicolas DesMarais

FOR
DIRECTOR GENERAL
ENGINEERING, PLANNING
AND STANDARDS

POUR
DIRECTEUR GÉNÉRAL
DU GÉNIE, DE LA
PLANIFICATION ET
DES NORMES



6.5. FCC Certificate

TCB

**GRANT OF EQUIPMENT
AUTHORIZATION**

TCB

**Certification
Issued Under the Authority of the
Federal Communications Commission
By:**

**RFI Global Services Ltd
Pavilion A Ashwood Park, Ashwood
Way
Basingstoke, Hampshire, RG23 8BG
United Kingdom**

**Date of Grant: 11/27/2009
Application Dated: 11/27/2009**

**Telit Communications S.p.A.
Viale Stazione di Prosecco 5/b
Trieste, 34010
Italy**

Attention: Andrea Fragiacomò , Ing.



NOT TRANSFERABLE
EQUIPMENT AUTHORIZATION is hereby issued to the named GRANTEE,
and is VALID ONLY for the equipment identified hereon for use under the
Commission's Rules and Regulations listed below.

**FCC IDENTIFIER: RI7GE864Q2
Name of Grantee: Telit Communications S.p.A.
Equipment Class: PCS Licensed Transmitter
Notes: Quadband GSM/ GPRS Module
Modular Type: Single Modular**

Grant Notes	FCC Rule Parts	Frequency Range (MHZ)	Output Watts	Frequency Tolerance	Emission Designator
	22H	824.2 - 848.8	1.74	27.0 Hz	300KGXW
	24E	1850.2 - 1909.8	0.93	71.0 Hz	300KGXW

Single modular approval. Power Output listed is conducted. This device contains functions that are not operational in U.S. Territories. This filing is only applicable for US operations. The antenna gain, including cable loss, must not exceed 3.0dBi at 1900 MHz / 1.4dBi at 850 MHz as defined in 2.1091 and 1.1307 of the rules for satisfying RF exposure compliance. The antenna(s) used for this transmitter must be installed to provide a separation distance of at least 20 cm from all persons and must not be co-located or operating in conjunction with any other antenna or transmitter within a host device, except in accordance with FCC multi-transmitter product procedures. OEM integrators and end-users must be provided with specific operating instructions for satisfying RF exposure compliance requirements.



TCB

**GRANT OF EQUIPMENT
AUTHORIZATION**

TCB

Certification
Issued Under the Authority of the
Federal Communications Commission
By:

RFI Global Services Ltd
Pavilion A Ashwood Park, Ashwood Way
Basingstoke, Hampshire, RG23 8BG United Kingdom
Date of Grant: 03/31/2010
Application Dated: 03/31/2010

Telit Communications S.p.A.
Viale Stazione di Prosecco 5/b
Trieste, 34010
Italy

Attention: Brian Tucker, Global VP, Quality

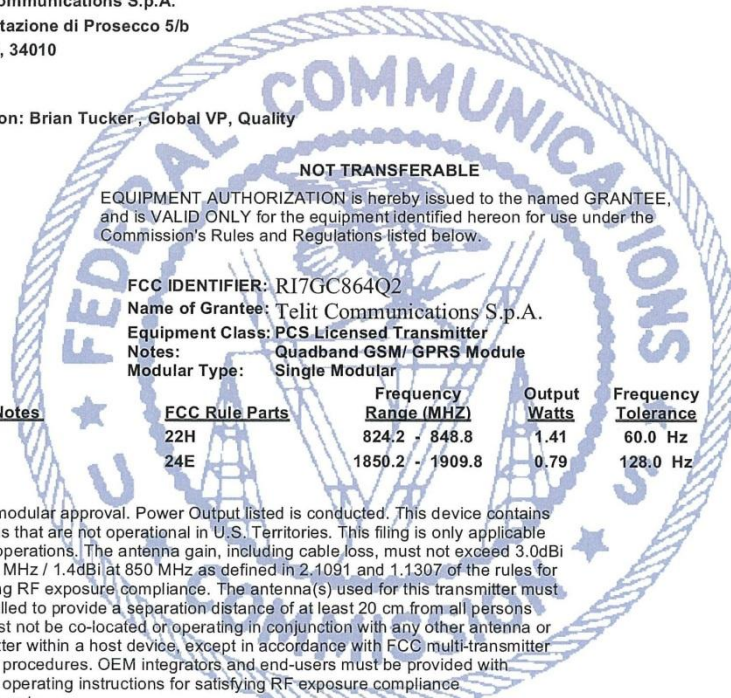

NOT TRANSFERABLE

EQUIPMENT AUTHORIZATION is hereby issued to the named GRANTEE, and is VALID ONLY for the equipment identified hereon for use under the Commission's Rules and Regulations listed below.

FCC IDENTIFIER: RI7GC864Q2
Name of Grantee: Telit Communications S.p.A.
Equipment Class: PCS Licensed Transmitter
Notes: Quadband GSM/ GPRS Module
Modular Type: Single Modular

<u>Grant Notes</u>	<u>FCC Rule Parts</u>	<u>Frequency Range (MHZ)</u>	<u>Output Watts</u>	<u>Frequency Tolerance</u>	<u>Emission Designator</u>
	22H	824.2 - 848.8	1.41	60.0 Hz	300KGXW
	24E	1850.2 - 1909.8	0.79	128.0 Hz	300KGXW

Single modular approval. Power Output listed is conducted. This device contains functions that are not operational in U.S. Territories. This filing is only applicable for US operations. The antenna gain, including cable loss, must not exceed 3.0dBi at 1900 MHz / 1.4dBi at 850 MHz as defined in 2.1091 and 1.1307 of the rules for satisfying RF exposure compliance. The antenna(s) used for this transmitter must be installed to provide a separation distance of at least 20 cm from all persons and must not be co-located or operating in conjunction with any other antenna or transmitter within a host device, except in accordance with FCC multi-transmitter product procedures. OEM integrators and end-users must be provided with specific operating instructions for satisfying RF exposure compliance requirements.



7. SAFETY RECOMMENDATIONS

READ CAREFULLY

Be sure the use of this product is allowed in the country and in the environment required. The use of this product may be dangerous and has to be avoided in the following areas:

- Where it can interfere with other electronic devices in environments such as hospitals, airports, aircrafts, etc
- Where there is risk of explosion such as gasoline stations, oil refineries, etc

It is responsibility of the user to enforce the country regulation and the specific environment regulation.

Do not disassemble the product; any mark of tampering will compromise the warranty validity.

We recommend following the instructions of the hardware user guides for a correct wiring of the product. The product has to be supplied with a stabilized voltage source and the wiring has to be conforming to the security and fire prevention regulations.

The product has to be handled with care, avoiding any contact with the pins because electrostatic discharges may damage the product itself. Same cautions have to be taken for the SIM, checking carefully the instruction for its use. Do not insert or remove the SIM when the product is in power saving mode.

The system integrator is responsible of the functioning of the final product; therefore, care has to be taken to the external components of the module, as well as of any project or installation issue, because the risk of disturbing the GSM network or external devices or having impact on the security. Should there be any doubt, please refer to the technical documentation and the regulations in force.

Every module has to be equipped with a proper antenna with specific characteristics. The antenna has to be installed with care in order to avoid any interference with other electronic devices and has to guarantee a minimum distance from the body (20 cm). In case of this requirement cannot be satisfied, the system integrator has to assess the final product against the SAR regulation.

The European Community provides some Directives for the electronic equipments introduced on the market. All the relevant information's are available on the European Community website:

<http://ec.europa.eu/enterprise/rtte/dir99-5.htm>

The text of the Directive 99/05 regarding telecommunication equipments is available, while the applicable Directives (Low Voltage and EMC) are available at:

http://ec.europa.eu/enterprise/electr_equipment/index_en.htm



8. List of acronyms

ACM	Accumulated Call Meter
ASCII	American Standard Code for Information Interchange
AT	Attention commands
CB	Cell Broadcast
CBS	Cell Broadcasting Service
CCM	Call Control Meter
CLIP	Calling Line Identification Presentation
CLIR	Calling Line Identification Restriction
CMOS	Complementary Metal-Oxide Semiconductor
CR	Carriage Return
CSD	Circuit Switched Data
CTS	Clear To Send
DAI	Digital Audio Interface
DCD	Data Carrier Detected
DCE	Data Communications Equipment
DRX	Data Receive
DSR	Data Set Ready
DTA	Data Terminal Adaptor
DTE	Data Terminal Equipment
DTMF	Dual Tone Multi Frequency
DTR	Data Terminal Ready
EMC	Electromagnetic Compatibility
ETSI	European Telecommunications Equipment Institute
FTA	Full Type Approval (ETSI)
GPRS	General Radio Packet Service
GSM	Global System for Mobile communication
HF	Hands Free
IMEI	International Mobile Equipment Identity
IMSI	International Mobile Subscriber Identity
IRA	International Reference Alphabet
ITU	International Telecommunications Union
IWF	Inter-Working Function
LCD	Liquid Crystal Display
LED	Light Emitting Diode
LF	Linefeed
ME	Mobile Equipment
MMI	Man Machine Interface
MO	Mobile Originated
MS	Mobile Station
MT	Mobile Terminated
OEM	Other Equipment Manufacturer
PB	Phone Book



PDU	Protocol Data Unit
PH	Packet Handler
PIN	Personal Identity Number
PLMN	Public Land Mobile Network
PUCT	Price per Unit Currency Table
PUK	PIN Unblocking Code
RACH	Random Access Channel
RLP	Radio Link Protocol
RMS	Root Mean Square
RTS	Ready To Send
RI	Ring Indicator
SCA	Service Center Address
SIM	Subscriber Identity Module
SMD	Surface Mounted Device
SMS	Short Message Service
SMSC	Short Message Service Center
SS	Supplementary Service
TIA	Telecommunications Industry Association
UDUB	User Determined User Busy
USSD	Unstructured Supplementary Service Data



9. Document History

Revision	Date	Changes
0	2009-11-07	First issue
1	2010-03-03	Added GC864-QUAD V2, DUAL V2 and GC864-QUAD V2 with SIM Holder
2	2010-09-02	removed GC/GE864-DUAL V2
3	2011-03-28	Added GE864-GPS characteristics and features §6: Updated Conformity certificates
4	2011-07-13	Applied new layout Updated disclaimer Added §5.8 “eCall Compliance”
5	2012-06-22	Added GE864-GPS FCC, IC, CE certifications and R&TTE NBO
6	2013-04-22	Updated Chapter 6 Conformity Assessment Issues

